

TWENTY YEARS OF FLUID EVOLUTION

OHHC



monobloc lobe pumps
BE series

ALL THE POWER WITH A DELICATE TOUCH

STANDARD VERSION



The BE SERIES Lobe Pumps derives from the well-known B series pump since it shares several of its characteristics. The AISI 316 L stainless steel pump is assembled on a cast iron gear box which has a protective coating in epoxy paint finish. The chamber separating the pump body and gear box avoids any contamination between the pumped fluid and the lubricant.

The BE series pumps are simple and robust and are characterised by their monobloc design. The drive unit, thanks to the hollow shaft and to the rear cover provided with an IEC flange, is directly fixed to the pump by creating a unique compact and light body.

The new design, with smooth cover and fixing nut built in the rotors, improves the cleaning (CIP) and sterilisation (SIP) standard.

The lobe pumps of this series are provided only with bi-lobe rotary piston rotors, in AISI 316 stainless steel or in antifriction alloy Acteon, which ensure an excellent volumetric efficiency and a smooth and regular transfer of several liquid or viscous products.

The bi-lobe rotary piston rotors have big chambers that close twice per revolution and make these pumps suitable for transferring fluids containing solids in suspension, from 10 mm. for the BE 115 model to 19 mm. for the BE 450 model.

Also in the BE series, the main parts (rotors, seals) and the optional parts can be added or changed according to different utilisation requirements. The wide range of available seals and gaskets (similar to those of the B series) allows an excellent choice according to the characteristics of the transferred product.

In less demanding works, the BE pumps can replace the B pumps and, meeting the increasing demand of cheap lobe pumps with a high sanitary standard, allow to widen the utilisation possibilities of the OMAC pumps.



SPECIAL VERSION

HEATED JACKET BODY



If it is necessary to keep the pumped fluid at a constant temperature a heated jacket body is available for all the pumps. This allows the circulation of heating or cooling liquid. Typical examples are melted fats, butter and margarine, chocolate and glucose. On request the heated jacket

front cover can be made available and it's own or with heated jacket on the body.

ENLARGED SUCTION INLET



The BE115, BE220, BE330, BE440 and BE450 Models can be supplied with enlarged rectangular suction inlets allowing highly viscous products such as semi-solid pieces to be pumped. In these cases the pump is generally positioned with the port on a vertical axis

in order to allow the entry of the product under gravity directly beneath the hopper.

PRESSURE RELIEF VALVE SYSTEMS



Integral pressure relief valve

The pumps can be supplied on request with hygienic by-pass or pressure relief valves. This device protects the pump from pressure peaks or restrictions in the discharge and assures excess liquid deviation during CIP and SIP. The relief valve can be manually selected as a flow regulator in order to pass product allowing the pump can be run continuously. This valve can be incorporated in the end cover that replace the standard cover, providing a pressure relief valve loop from discharge to the suction area; alternatively it can be incorporated in the discharge pipework, relieving excess pressure by by-passing product through a loop back to the suction side. The integral relief

valve is suitable for CIP process line and functions for either direction of flow. The external pressure relief valve (unidirectional) can be assembled in order to recycle the whole pumped product. This valve is especially suitable for frequently operations and for volatile, heat or shear sensitive product. For both of the valves a manual, pneumatic or automatic operation is available.



External pressure relief valve

MOUNTING AND DRIVES



The new OMAC pumps can be supplied either bare shaft or complete with directly flanged drive unit. The pump unit becomes very compact without bare rotation shafts and with minimum dirt-collecting surfaces. Trolleys and such accessories as feet for vertical connections, adjustable feet, and stainless steel shrouds covering the motors can also be supplied as to build pumping sets which exactly satisfy customer's requirements. Power transmission can be variable speed via mechanical, hydraulic, belt adjustable speed unit or inverter integrated into the motor; alternatively can be fixed speed via reduction geared motor. For controlling the pumps the options are various and these include on off reversing switch, IP65 inverter, electric panel with IP21 inverter for remote control signal.

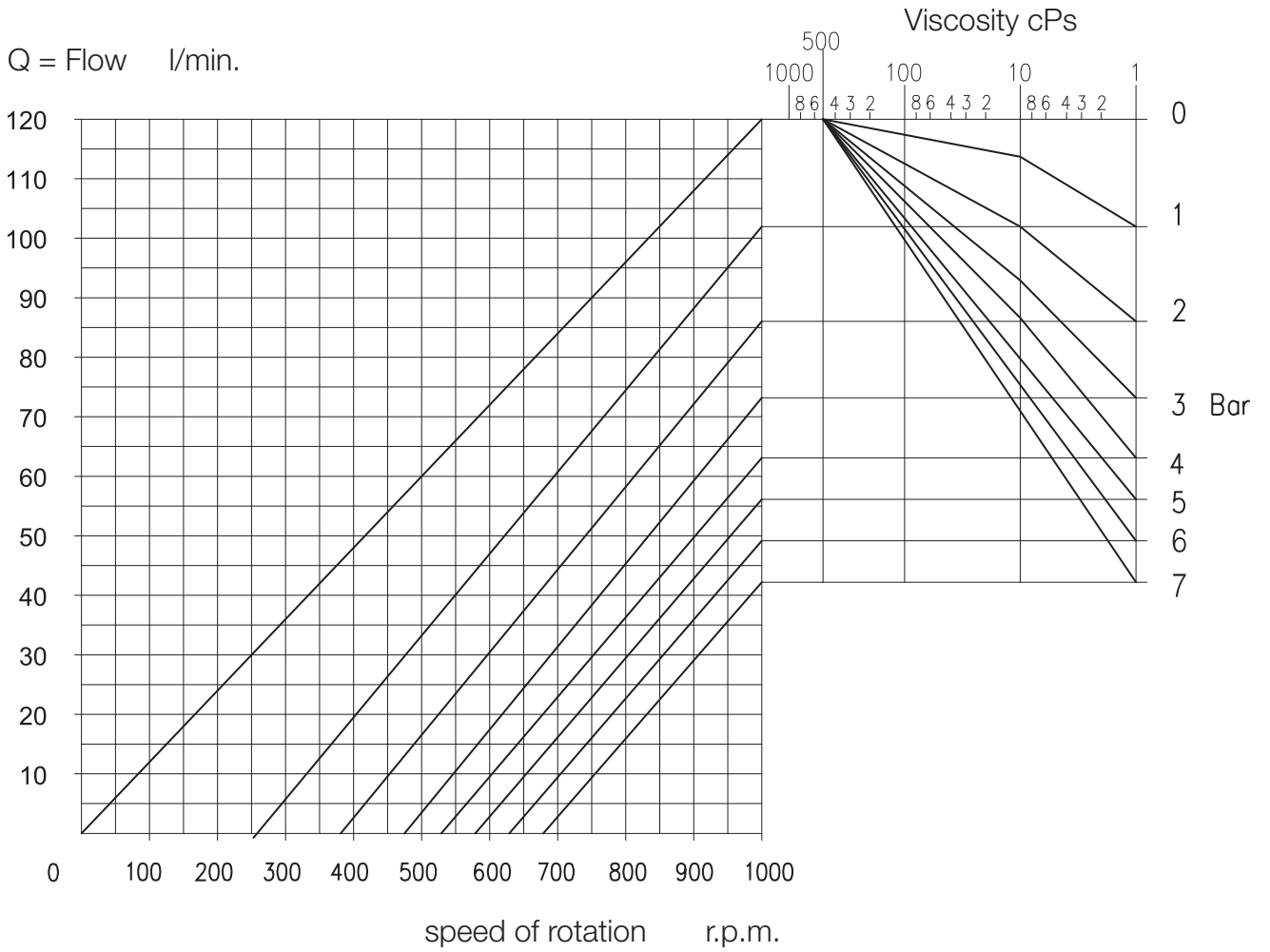

Kw = absorbed power

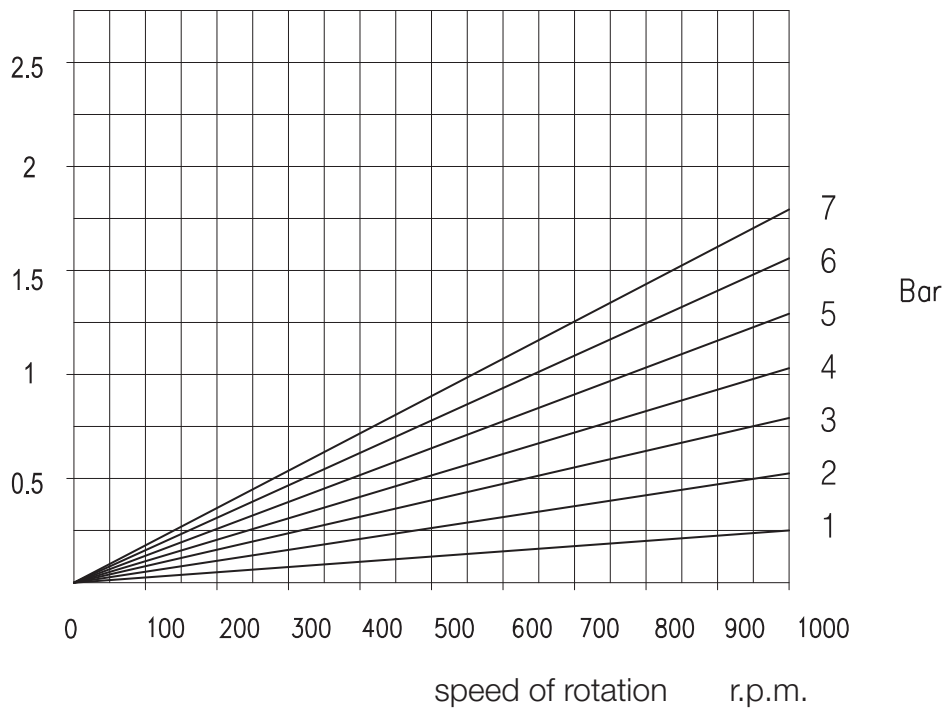

Q = Flow l/min.

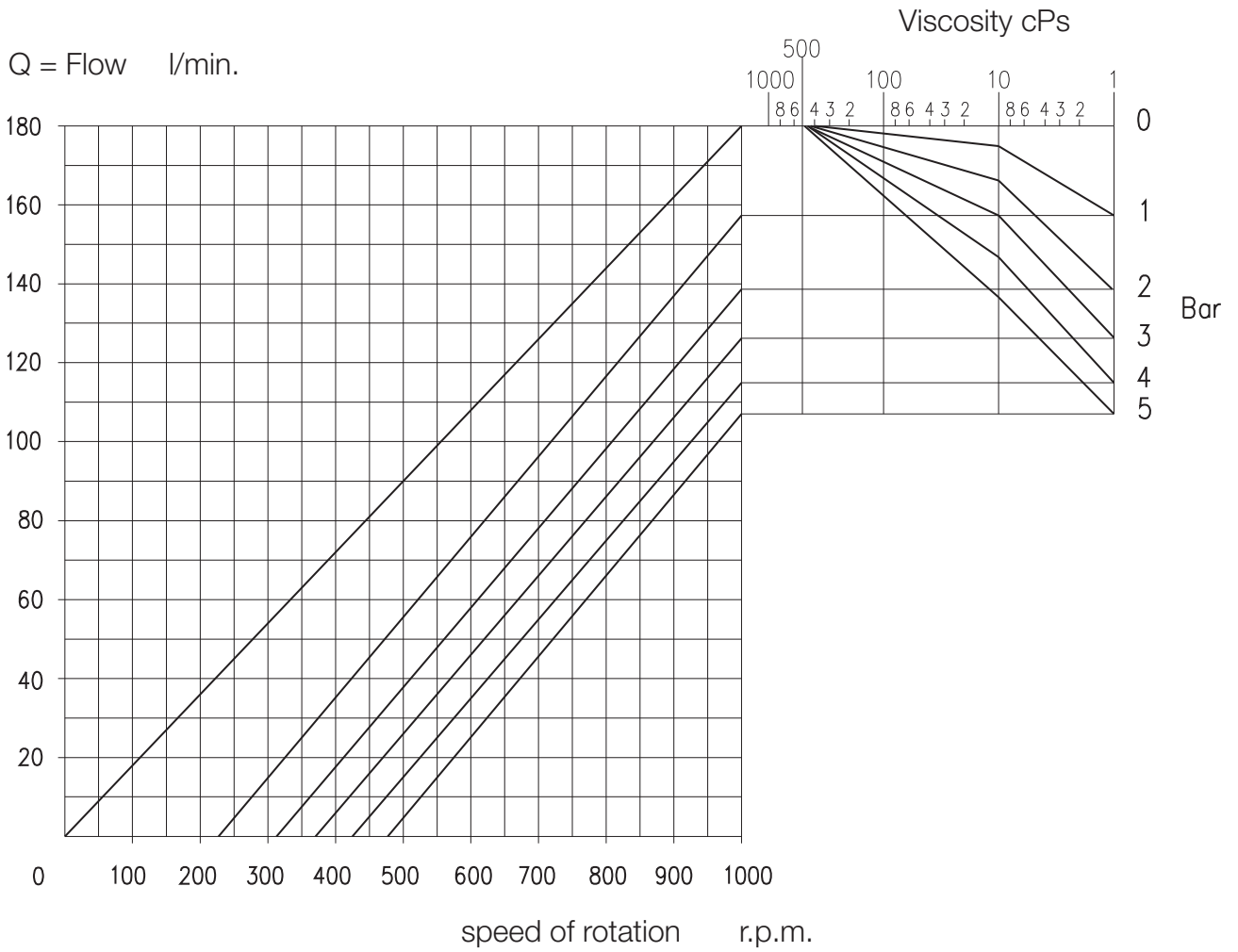

Kw = absorbed power

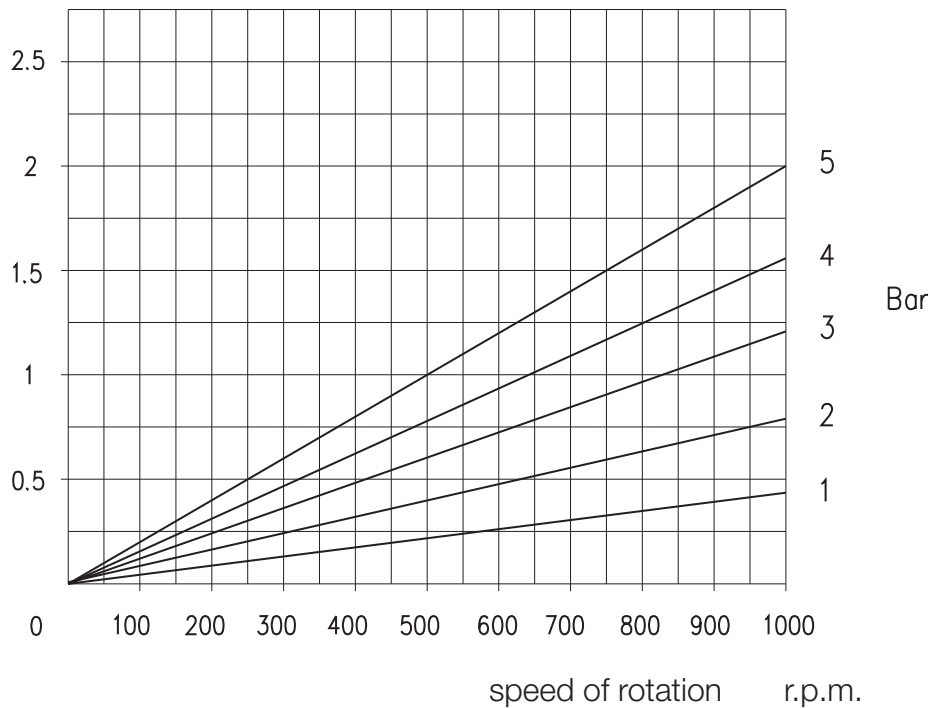



PUMP PERFORMANCES CHART

BE220

Stainless Steel Dual Wing Rotary Piston

version ST

cod=0

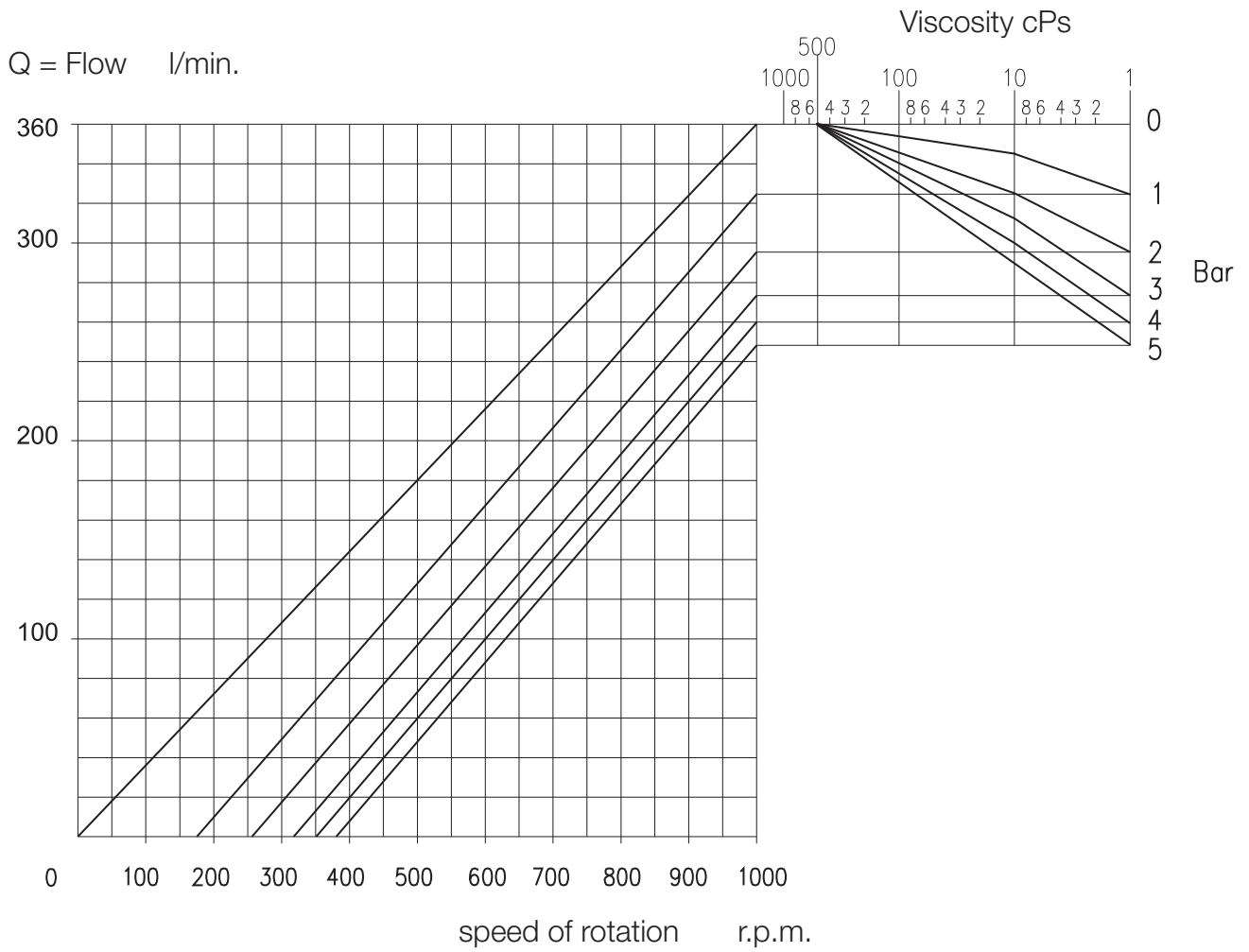

Kw = absorbed power

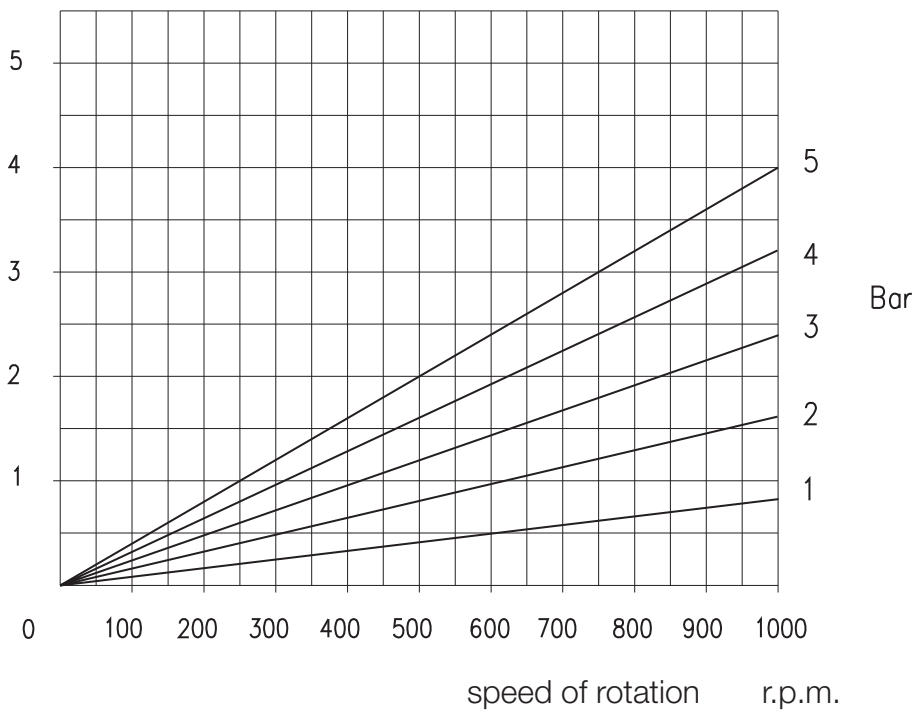

Q = Flow l/min.

Viscosity cPs

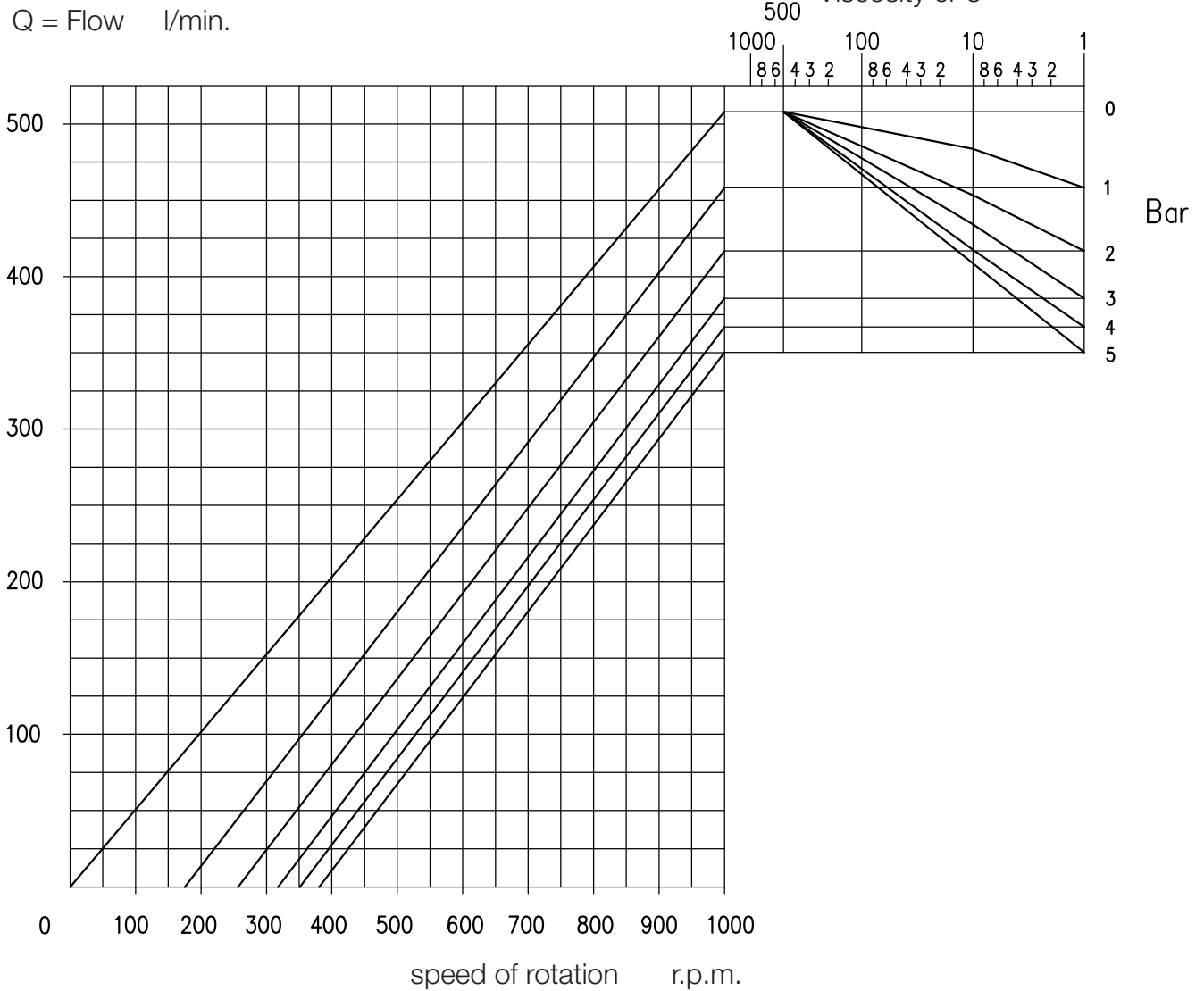

Kw = absorbed power

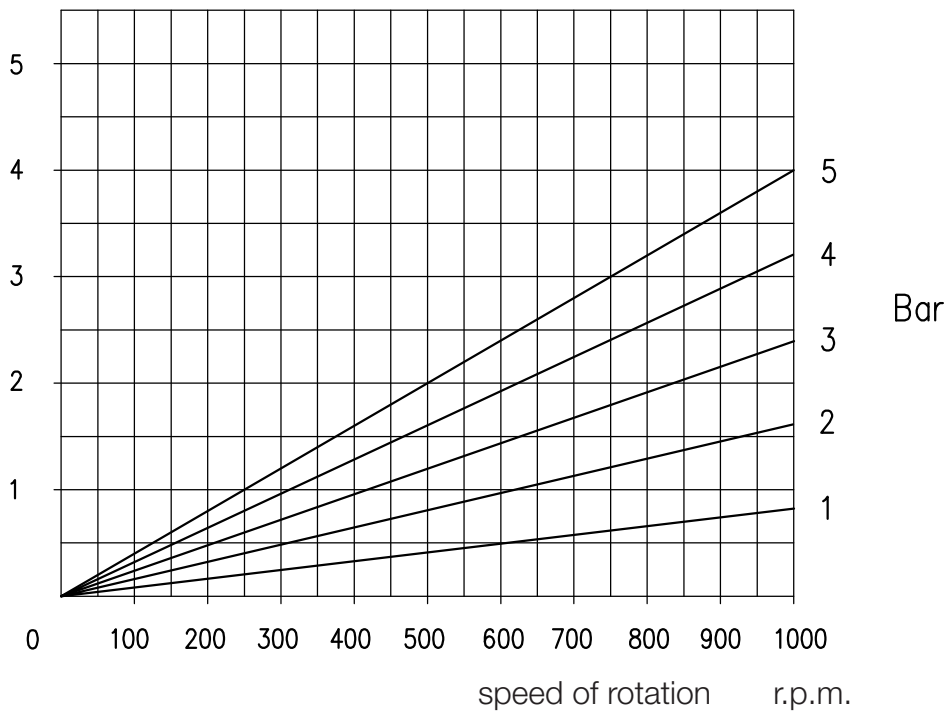



PUMP PERFORMANCES CHART

BE330

Stainless Steel Dual Wing Rotary Piston

version ST

cod=0

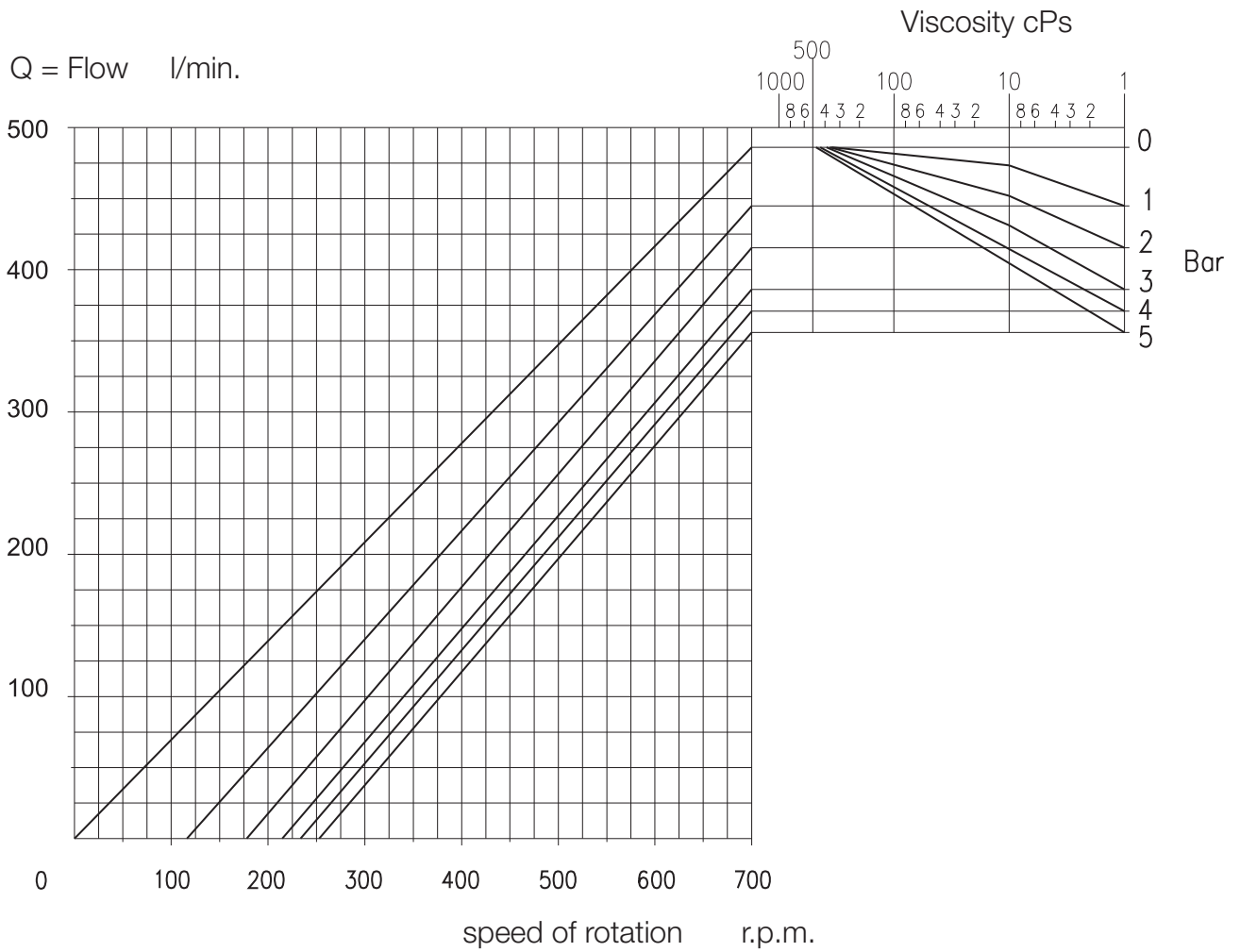

Kw = absorbed power

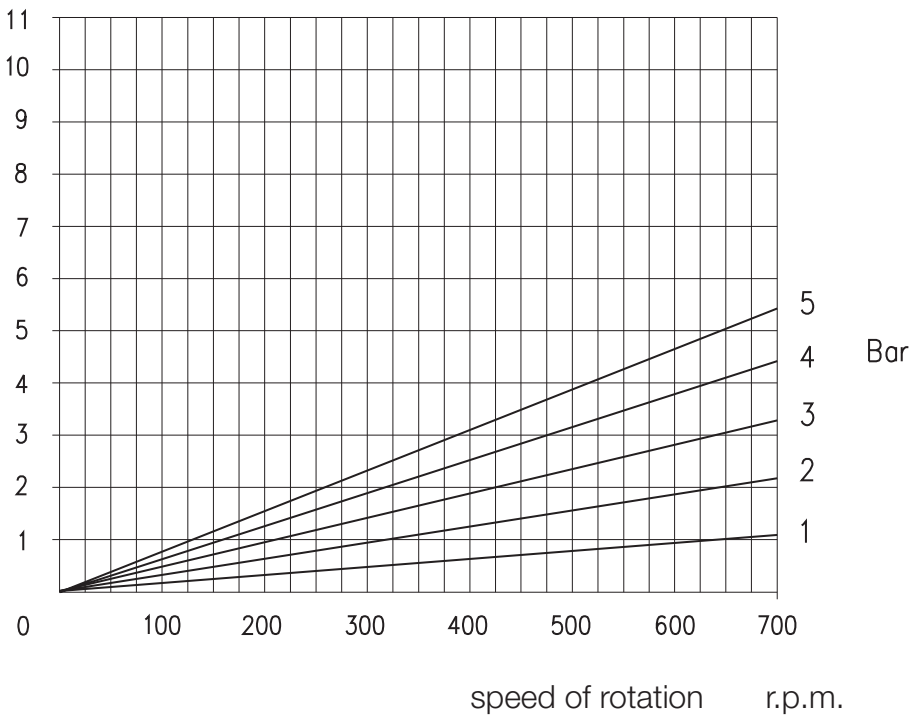

Q = Flow l/min.

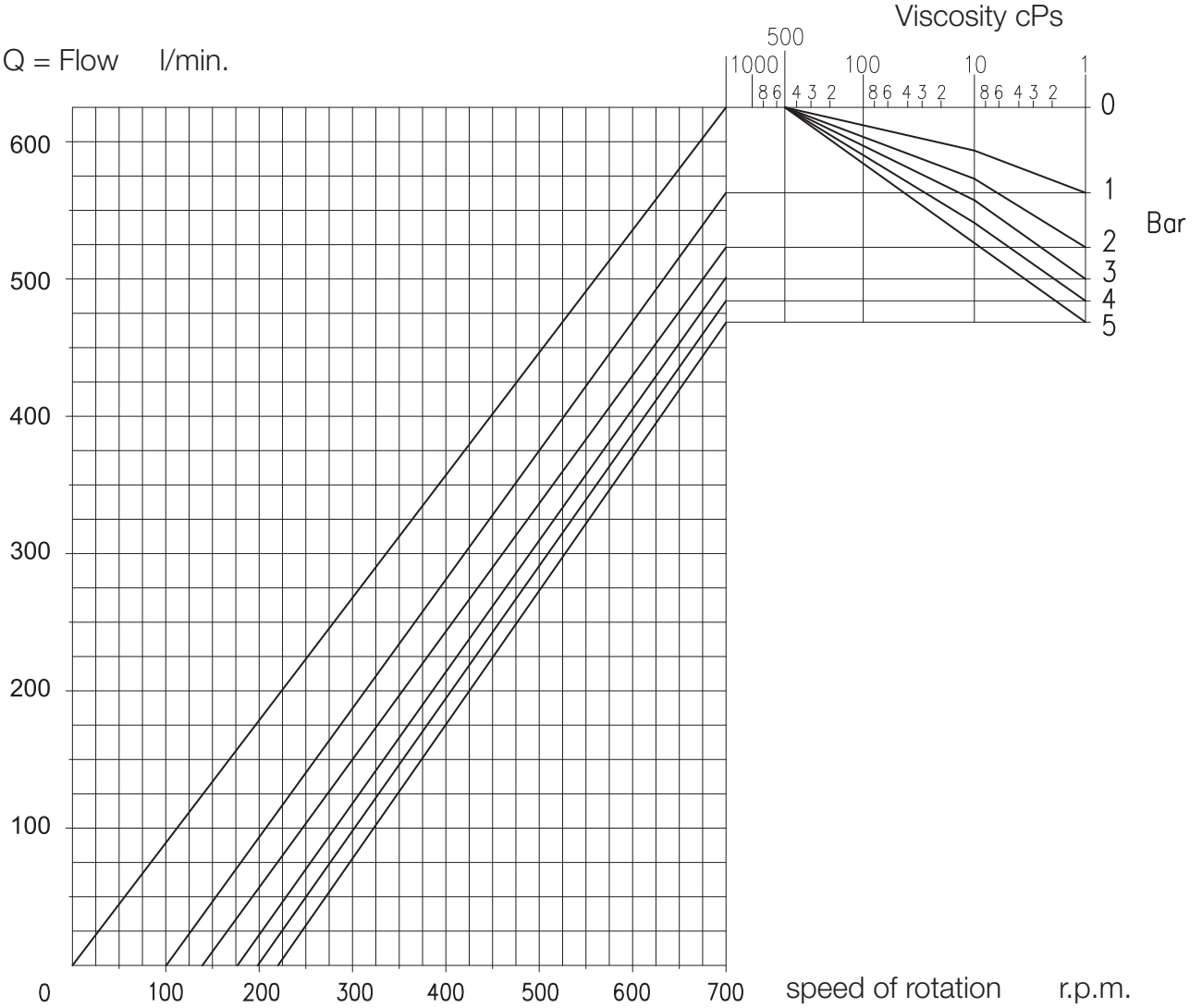

Kw = absorbed power

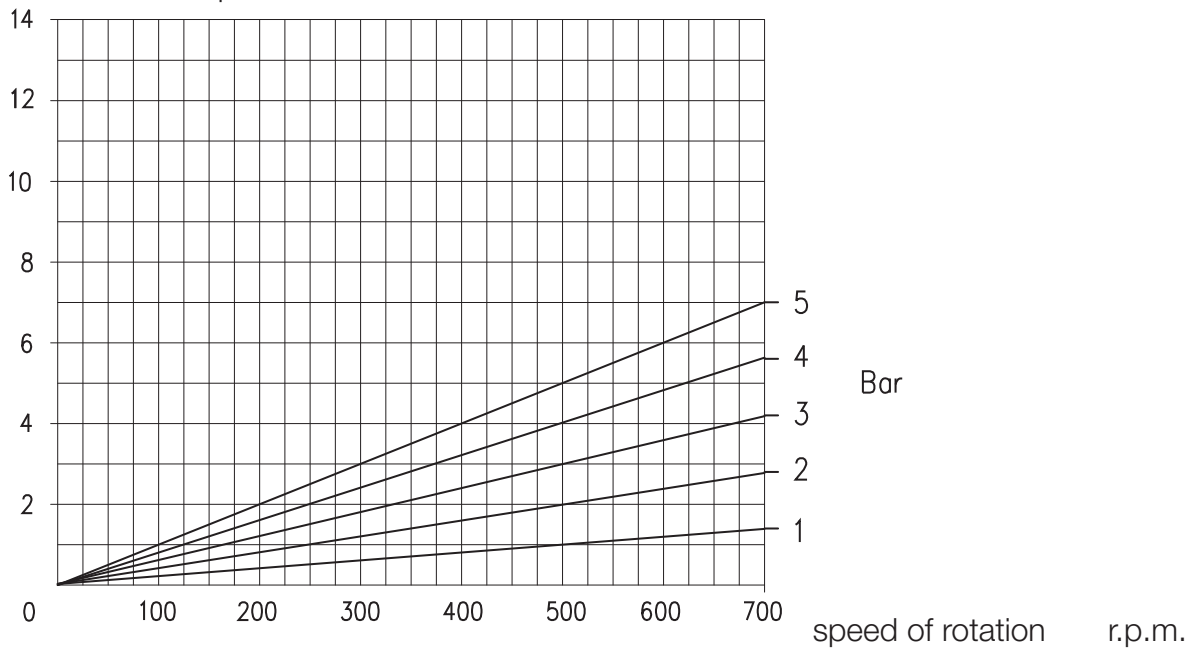



PUMP PERFORMANCES CHART

BE440 Stainless Steel Dual Wing Rotary Piston

version ST

cod=0

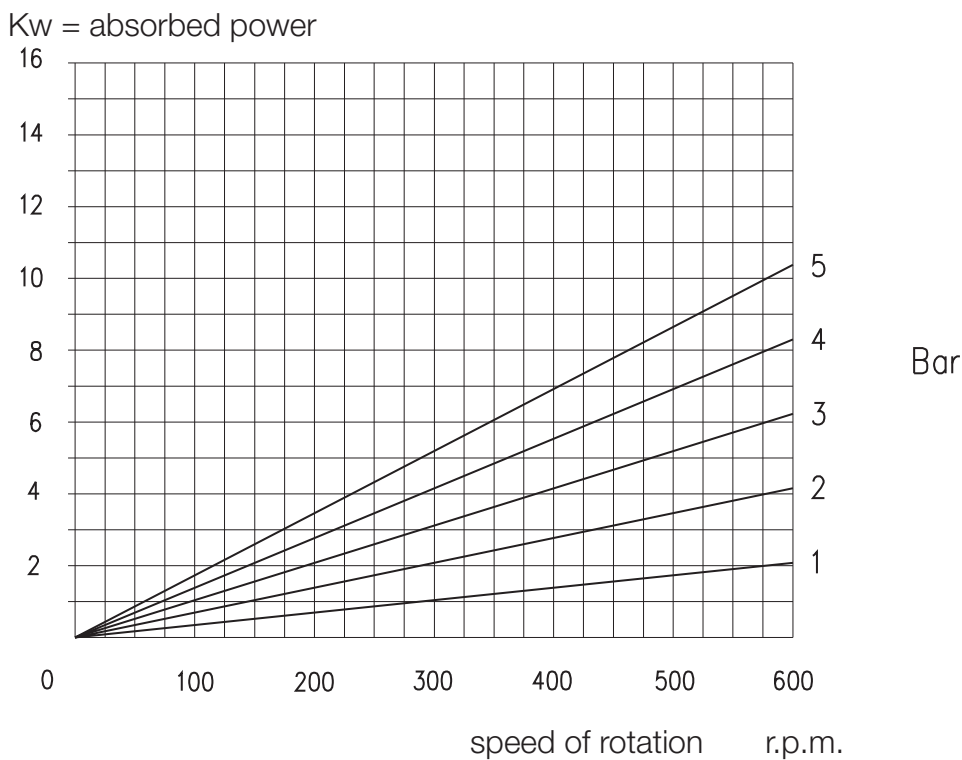
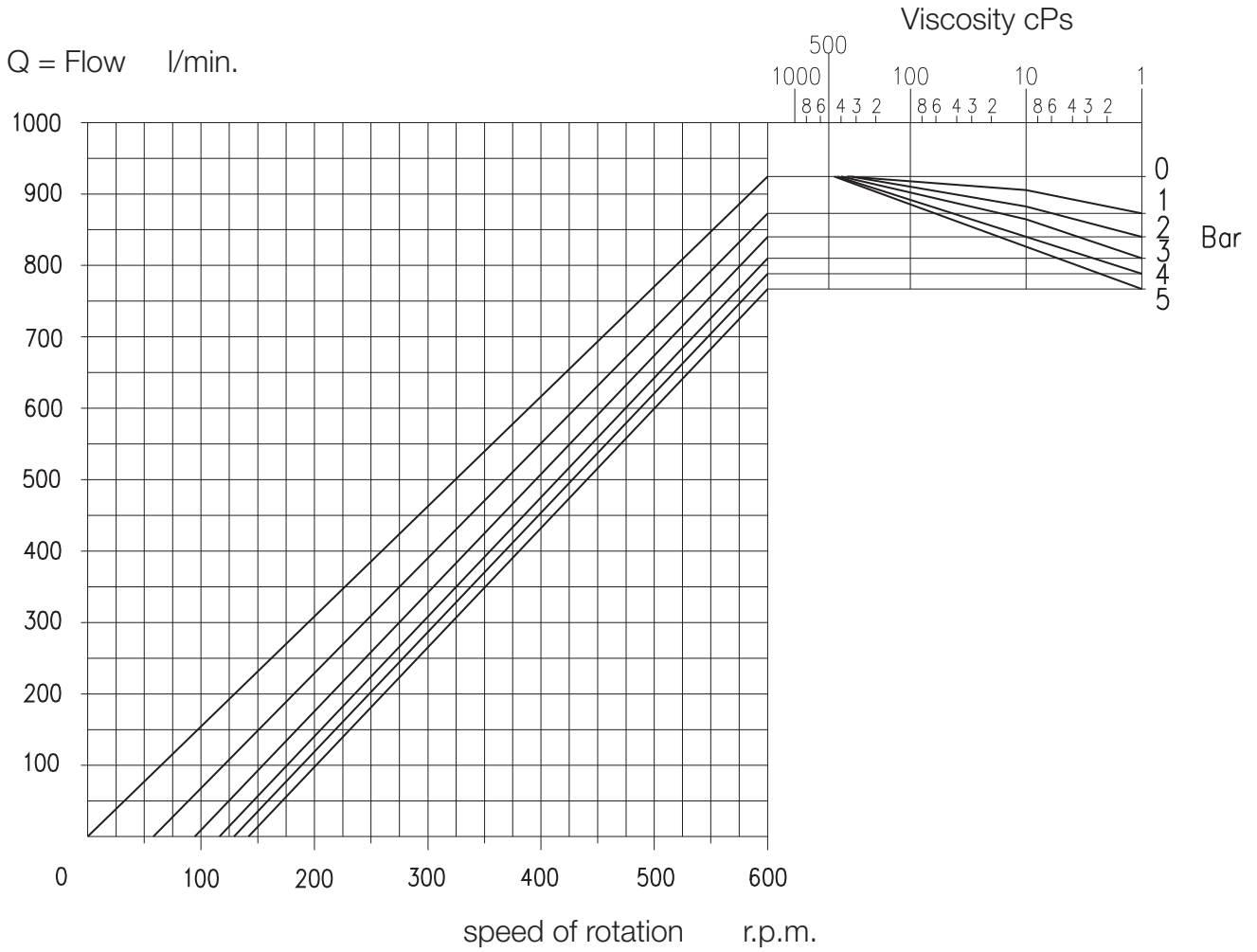

Q = Flow l/min.

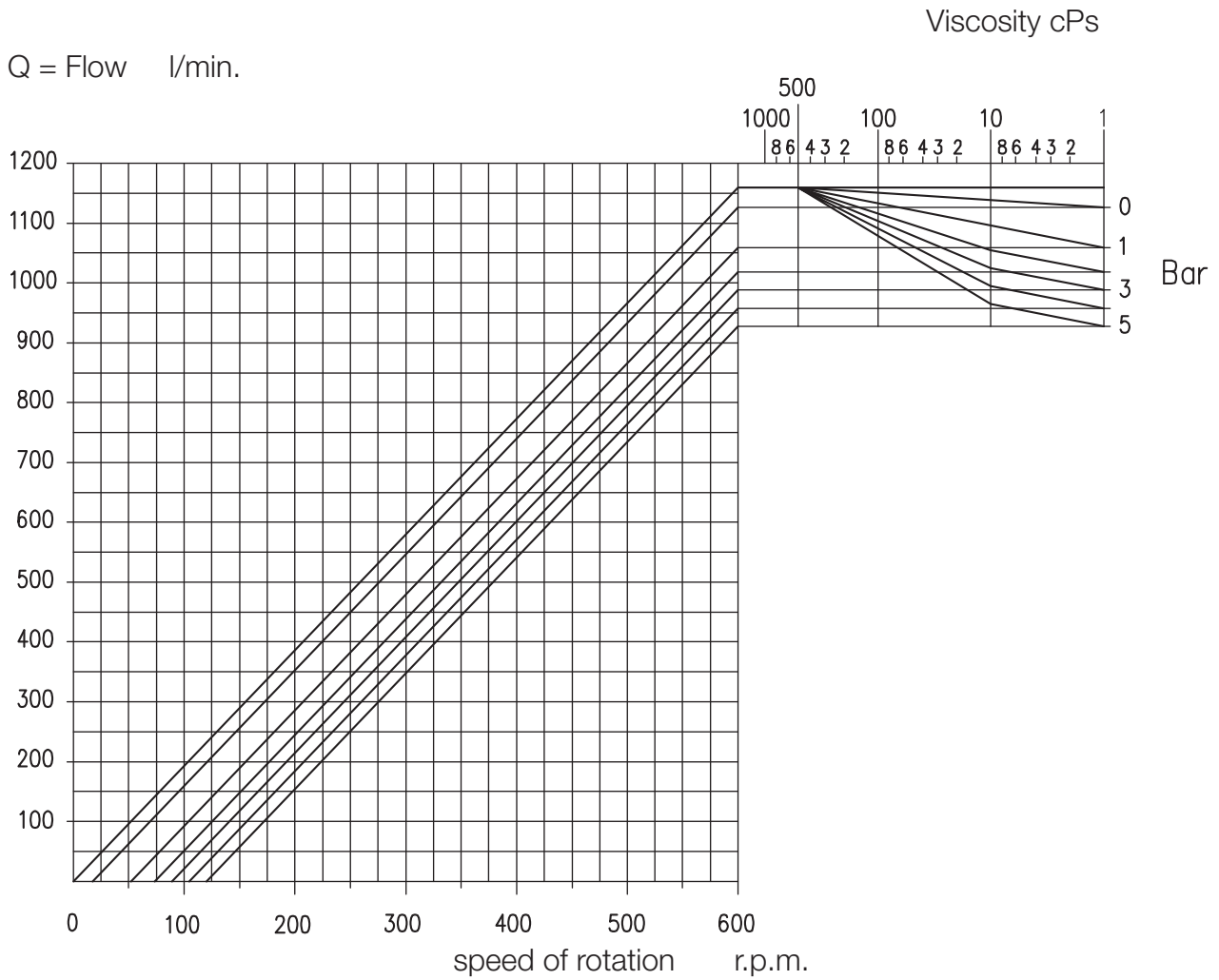

Kw = absorbed power

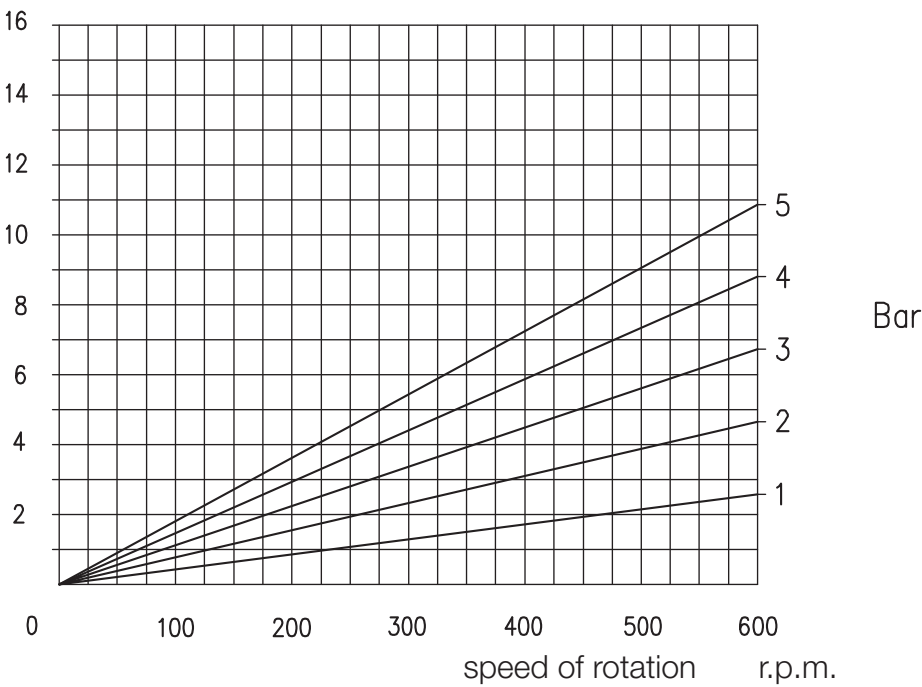

TECHNICAL DATA

HYDRAULIC CHARACTERISTICS

PUMP MODEL	THEORETIC CAPACITY lt/100 giri	MAX SPEED	MAX POWER kw	MAX PRESSURE bar
BE110	12	1000	2,2	7
BE115	18	1000	2,2	5
BE220	34	950	4	5
BE270	48	950	4	5
BE330	70	700	5,5	5
BE390	90	700	5,5	5
BE440	155	600	9,2	5
BE450	193	600	9,2	5

OVERALL DIMENSIONS IN MM.

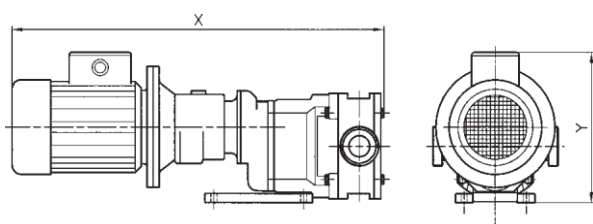

WITH GEARED MOTOR

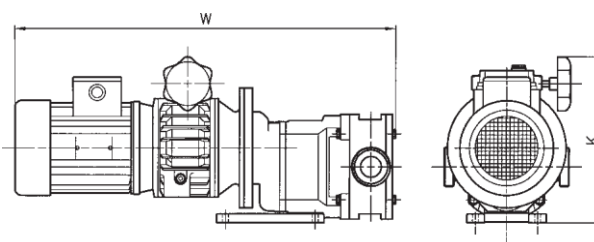

WITH VARIABLE SPEED MOTOR

TYPE PUMP		BE 110						BE 115						BE 220						BE 270					
OVERALL DIMENSIONS*		X	Y	W	K	P ₁	P ₂	X	Y	W	K	P ₁	P ₂	X	Y	W	K	P ₁	P ₂	X	Y	W	K	P ₁	P ₂
POWER KW	0,75	639	240	624	277	34	54	651	240	636	277	35	55												
	1,1							701	274	706	311	45	65	773	286	765	351	65	130	789	286	781	351	66	131
	1,5													773	286	765	351	70	135	789	286	781	351	71	136
	2,2													793	303	872	384	75	145	789	303	888	384	76	146
	3																								
	4																								
	5,5																								
	7,5																								
9,2																									

TIPO DI POMPA		BE 390						BE 440						BE 450											
OVERALL DIMENSIONS*		X	Y	W	K	P ₁	P ₂	X	Y	W	K	P ₁	P ₂	X	Y	W	K	P ₁	P ₂	X	Y	W	K	P ₁	P ₂
POWER KW	0,75																								
	1,1																								
	1,5																								
	2,2	882	328	944	409	100	165	1002	328	964	409	101	166												
	3	882	328	944	409	105	170	1002	328	964	409	106	171												
	4	882	349	944	409	110	175	1002	349	964	409	111	176	949	393	1019	474	180	245	969	393	1039	474	180	245
	5,5													1090	430	1139	521	260	1110	1110	430	1159	521	260	1110
	7,5													1090	430	1139	521	275	1110	1110	430	1159	521	275	1110
9,2													1090	430	1139	521	280	1110	1110	430	1159	521	280	1110	

P₁[kg] = Weight: PUMP WITH GEARED MOTOR

P₂[kg] = Weight: PUMP WITH VARIABLE SPEED MOTOR

* Approximate dimensions to confirm according to available drives

OVERALL DIMENSIONS IN MM. WITH IEC FLANGE FOR MOTORIZATION CONNECTION

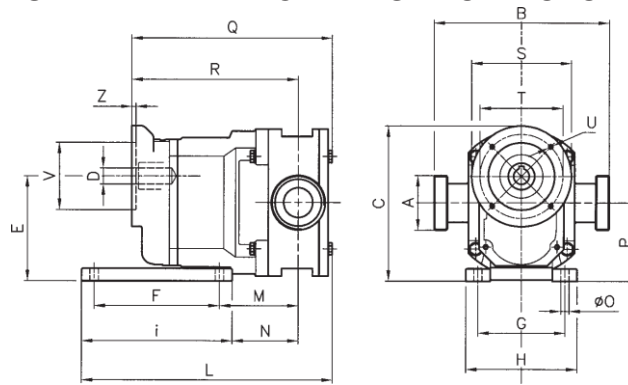

TYPE PUMP GAS-BSP PORTS	POSITION																				WEIGHT	
	A	B	C	D	E	F	G	H	I	L	M	N	O	P	Q	R	S	T	U	V		Z
BE110-F1	1 1/2	170	185	19	125	150	105	134	180	291	82.5	67.5	10	93,5	231	188	120	100	M6 (8)	80	5	20
BE110-F2			185	20											231	188	120	100	M6 (8)	80	5	20
BE110-F3			285	19											245	201	200	165	M10 (4)	130	4	22
BE110-F4			285	24											245	201	200	165	M10 (4)	130	4	22
BE110-F5			205	24											245	201	160	130	M8 (4)	110	4	21
BE110-F6			185	24											231	188	120	100	M6 (8)	80	5	20
BE110-F7			205	20											245	202	160	130	M8 (4)	110	4.5	21
BE110-F8			205	19											245	202	160	130	M8 (4)	110	4.5	21
BE115-F1	1 1/2	170	185	19	125	150	105	134	180	303	94	79	10	93.5	243	199	120	100	M6 (8)	80	5	20
BE115-F2			185	20											243	199	120	100	M6 (8)	80	5	20
BE115-F3			285	19											257	213	200	165	M10 (4)	130	4	22
BE115-F4			285	24											257	213	200	165	M10 (4)	130	4	22
BE115-F5			205	24											257	213	160	130	M8 (4)	110	4	21
BE115-F6			185	24											243	199	120	100	M6 (8)	80	5	20
BE115-F7			205	20											257	213	160	130	M8 (4)	110	4.5	21
BE115-F8			205	19											257	213	160	130	M8 (4)	110	4.5	21
BE220-F1	2"	208	245	25	165	170	125	160	200	359	119	104	12	127.5	311	256	160	130	M8 (4)	110	4.5	43
BE220-F2			290	28											327	272	250	215	M12 (4)	180	5	47
BE220-F3			245	28											311	256	160	130	M8 (4)	110	4.5	43
BE220-F4			265	28											327	272	200	165	M10 (4)	130	4.5	44
BE270-F1	2"	208	245	25	165	170	125	160	200	375	127	112	12	127.5	327	264	160	130	M8 (4)	110	4.5	44
BE270-F2			290	28											343	280	250	215	M12 (4)	180	5	48
BE270-F3			245	28											327	264	160	130	M8 (4)	110	4.5	44
BE270-F4			265	28											343	280	200	165	M10 (4)	130	4.5	45
BE330-F1	3"	236	290	30	190	200	140	180	240	443	151	131	14	145	389	339	200	165	M10 (4)	130	4.5	65
BE330-F2			315	28											405	351	250	215	M12 (4)	180	5	68
BE330-F3			290	28											389	317	200	165	M10 (4)	130	4.5	65
BE390-F1	3"	336	290	30	190	200	140	180	240	458	171	151	14	145	409	337	200	165	M10 (4)	130	4.5	69
BE390-F2			315	28											425	353	250	215	M12 (4)	180	5	72
BE390-F3			290	28											409	337	200	165	M10 (4)	130	4.5	69
BE440-F1	4"	335	355	30	255	250	190	240	300	530	157.5	132.5	18	192.5	453	367.5	200	165	M10 (4)	130	5	135
BE440-F2			405	48											473	387.5	300	265	M12 (4)	230	6	142
BE440-F3			350	40											470	384	250	215	M12 (4)	180	5	139
BE450-F1	4"	335	355	30	255	250	190	240	300	550	167.5	142.5	18	192.5	473	377.5	200	165	M10 (4)	130	5	140
BE450-F2			405	48											493	397.5	300	265	M12 (4)	230	6	147
BE450-F3			350	40											490	394	250	215	M12 (4)	180	5	144

PUMPS WITH PORTS:

TYPE PUMP	UNI2278 PN16 FLANGED PORTS		DIN 11851		SMS		IDF-ISS		RJT		TRI-CLAMP		OENOLOGICAL	
	A	B	A	B	A	B	A	B	A	B	A	B	A	B
BE110/115	DN40	186	DN40	210	DN38	210	DN38	210	DN38	210	DN 1 1/2	210	DN40	218
BE220/270	DN50	228	DN50	228	DN51	248	DN51	248	DN51	248	DN 2"	248	DN50	256
BE330/390	DN80	256	DN80	296	DN76	296	DN76	276	DN76	276	DN 3"	290	DN80	290
BE440/450	DN100	355	DN100	395	DN101	395	DN101	378	DN101	378	DN 4"	392	DN100	389

SOME PUMPED PRODUCTS

vinegar	ketchup	tomato purée
distilled water	milk	diced tomaatoes
hydrogen	condensed milk	perfumes
peroxide	latex	mashed potato
alcohol	yeast	fruit purée
adhesives	liquor	brine
beer	lotions	sauces
soup	mayonnaise	blood
melted butter	malt	soap
curd	melted margarine	syrup
mincemeat	jam	shampoo
chocolate	marzipan	caustic soda
glue	molasses	galvanic solution
cream	mushroom	sugar solution
toothpaste	honey	solvents
detergents	coconut oil	fruit juice
emulsions	olive oil	tea
explosives	baby food	surfactants for
essences	sponge-cake	detergents
milk enzymes	cream	tointment
strawberries	paraffin	eggs
ice-cream	suppository	vaseline
gelatine	paste	paint
icing	hand cleaning	wine
glycerine	paste	yoghurt
glucose	polymers	
animal grease	fruit pulp	

INDUSTRIAL APPLICATIONS

COSMETICS:	beauty creams, toothpaste, shampoo, detergents, lotions
CHEMICAL:	paints, enamels, detergents, polymers, resins, dodecylbenzene, acids, etc.
BEVERAGES:	wine, alcohol, beer, soft drinks, syrup, tea, fruit juice, grape juice, mineral water
FOOD:	fruit and tomato concentrates, fruit and vegetable salads, preserved vegetables, sauces, mayonnaise, homogenized meat, starch, vegetable purées, etc.
CONFECTIONERY:	chocolate, cream, sponge-cake, products with yeast, fillings, fats, margarine, jam, marmalade
DAIRY:	milk and its products, sofft cheese, yoghurt, fruit for yoghurt, butter, curd, cream, whey, etc.

DEALER



O.M.A.C. S.r.l. Via G. Falcone, 8 - 42048 RUBIERA (RE) - ITALY
TEL. 0522 629371-629923 - FAX 0522 628980
www.omacpompe.com - E-mail: info@omacpompe.com

